



F



F

F

F

F

F

F

F

F

F

F

F





-
-
-
-
-

F

	F

F

F

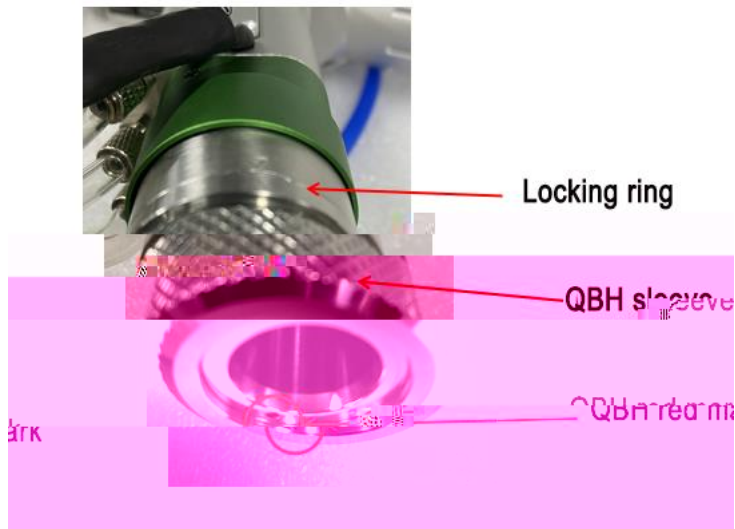
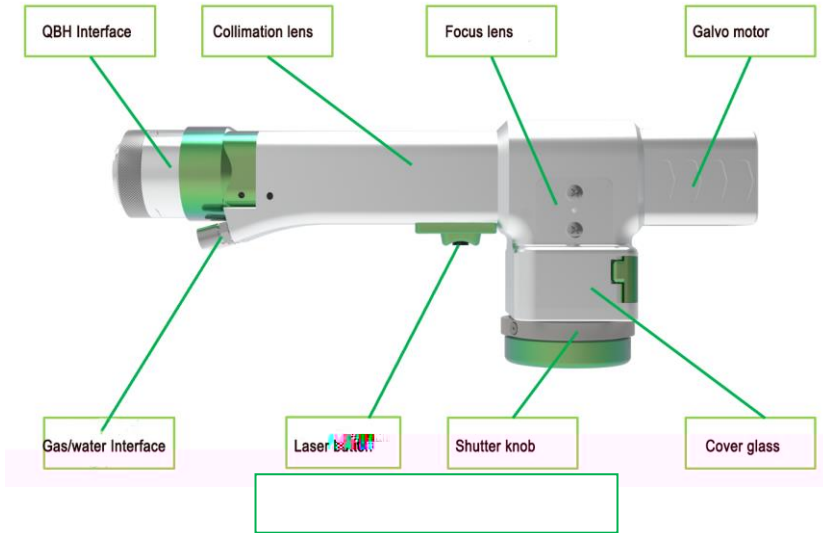

2

Fiber output head (QBH)



F

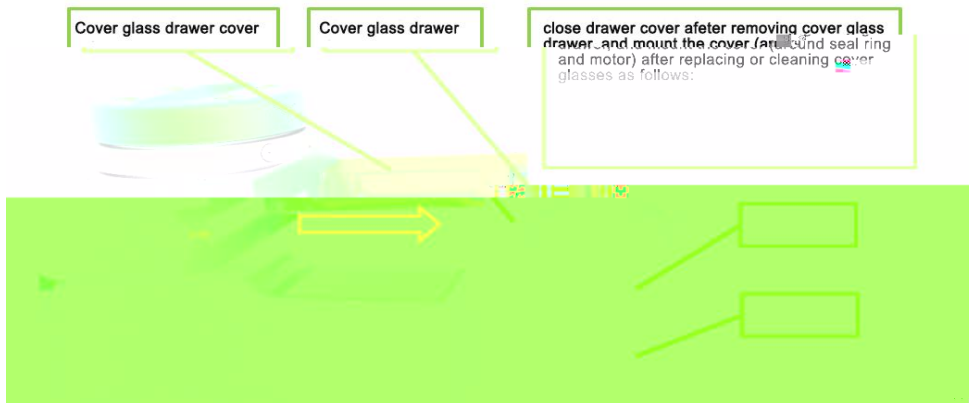
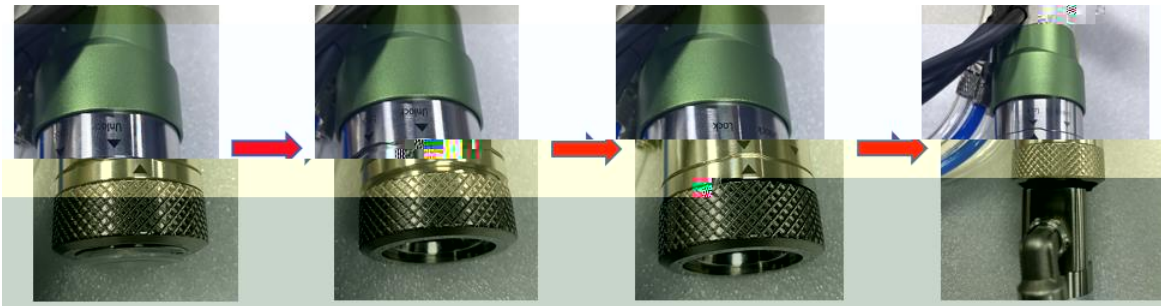

F

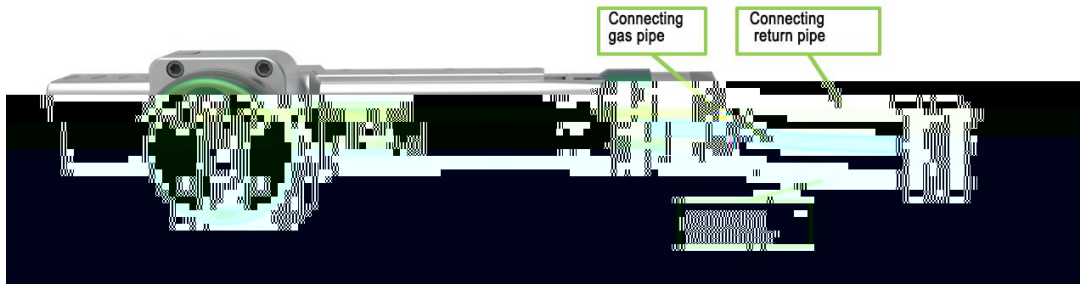

F

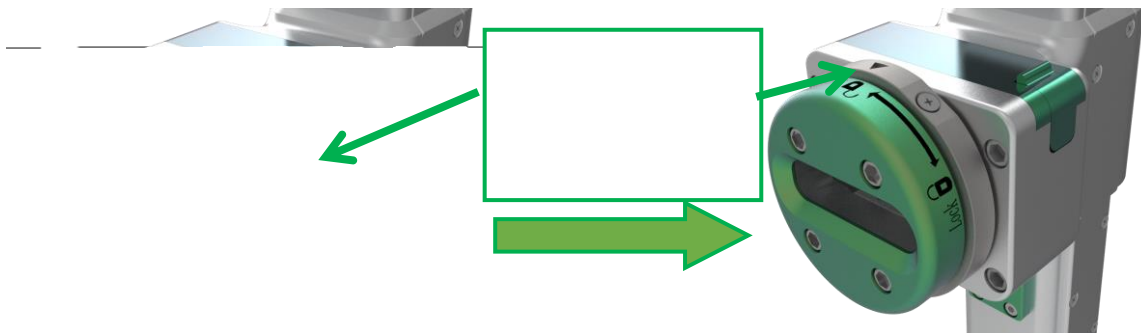

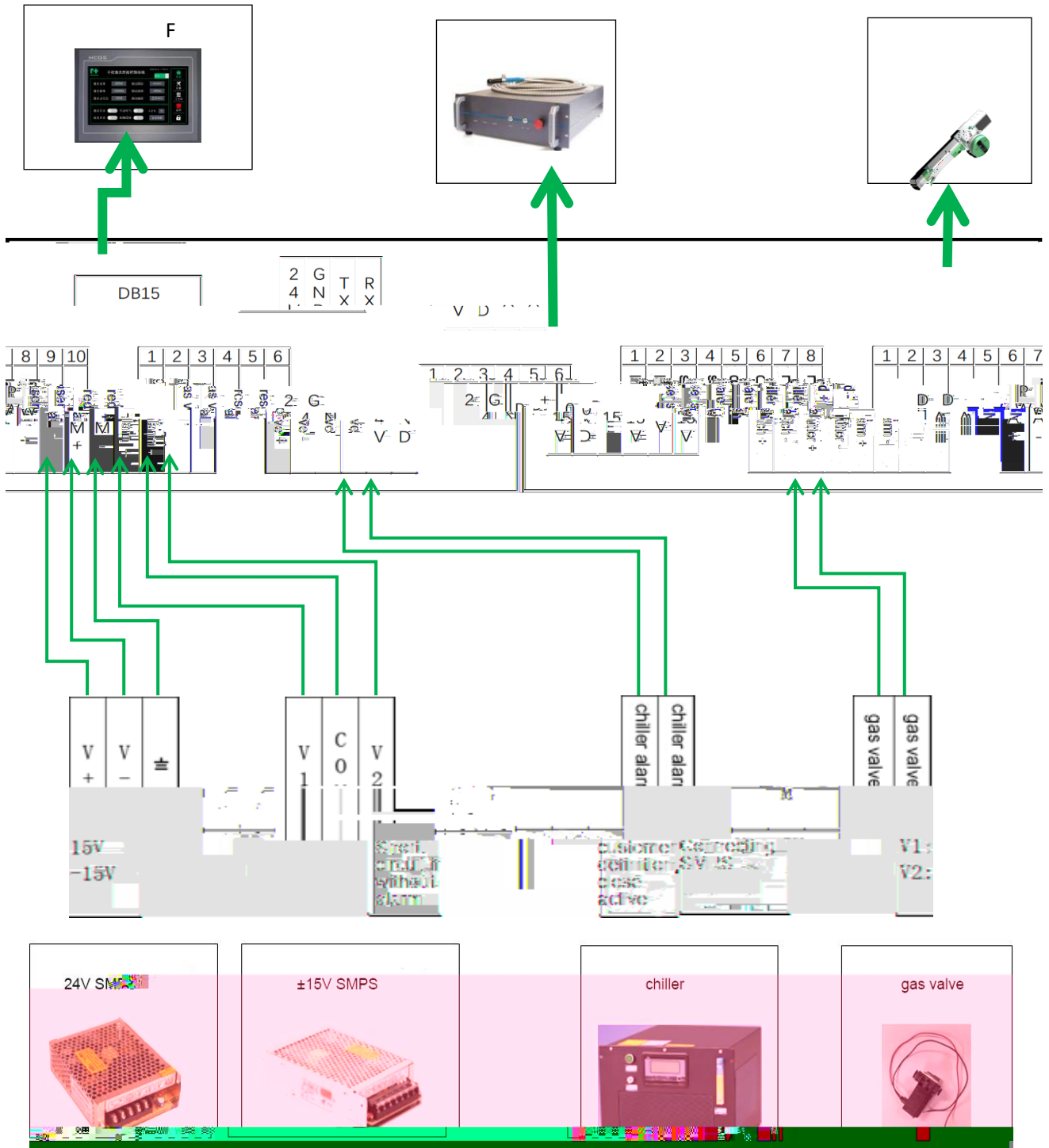



± F ± ±

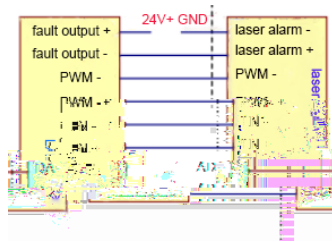

±
F
F ± F

F

±
±



±

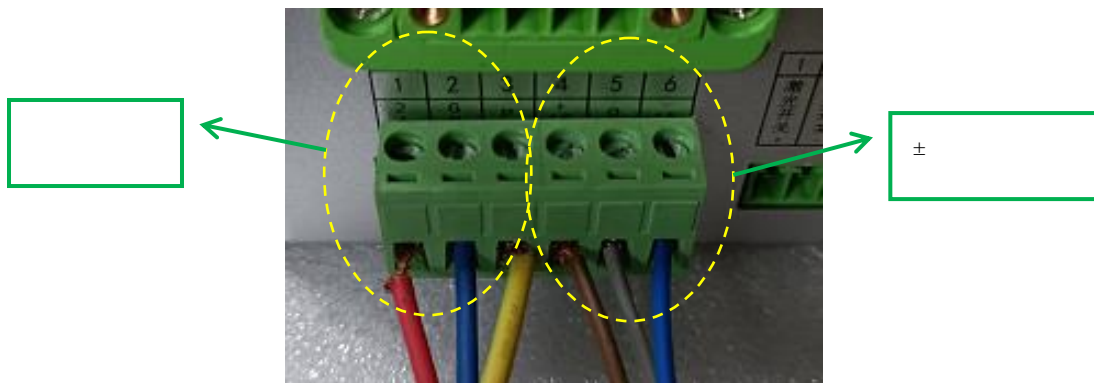

± F
F

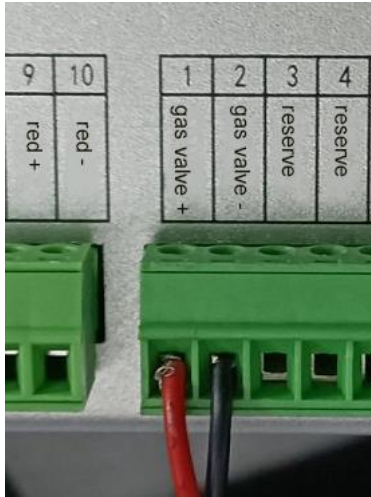

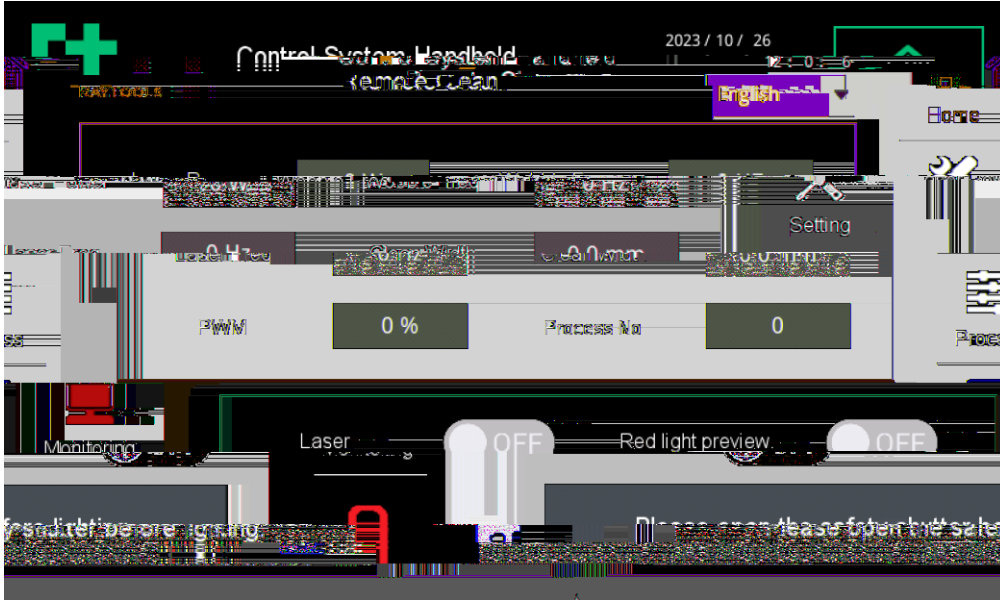

Laser Power

F

Laser Freq

PWM

F

Wobble Free

Clean Width

Laser

Red light preview

Process No

F

F

Please read the safety sheet before using the device.

F

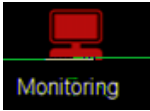
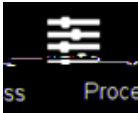

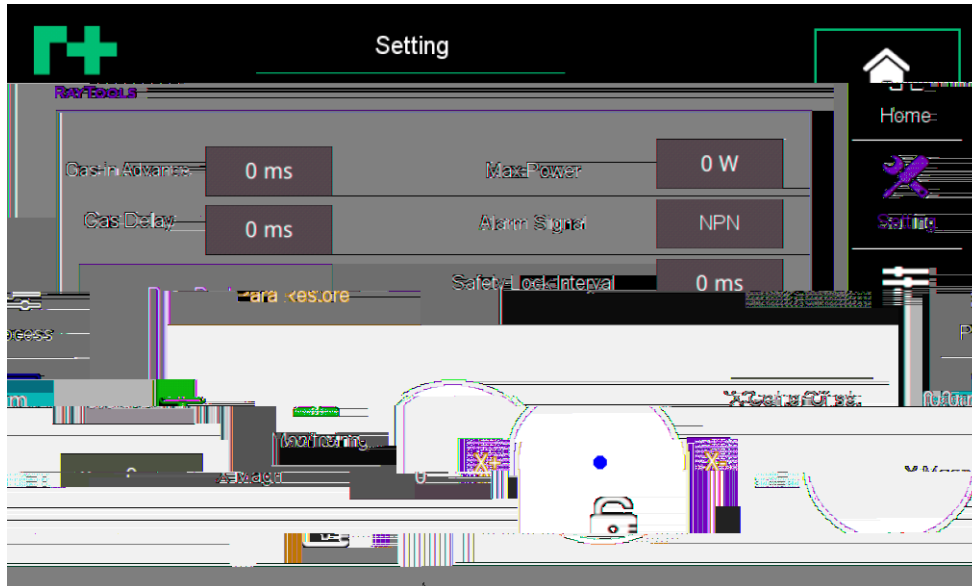

Gas in Advance

Gas Delay

Max Power

F

Alarm Signal

F

Safety Lock Interval

X Magn

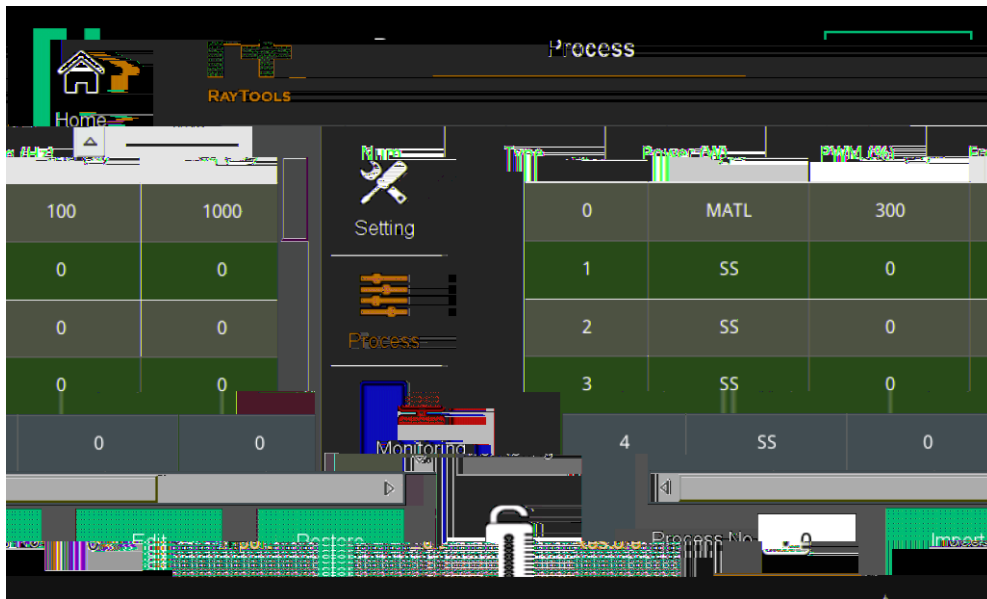

- F F
- Process No F
- Import
- Edit
- Restore

- F F
- F

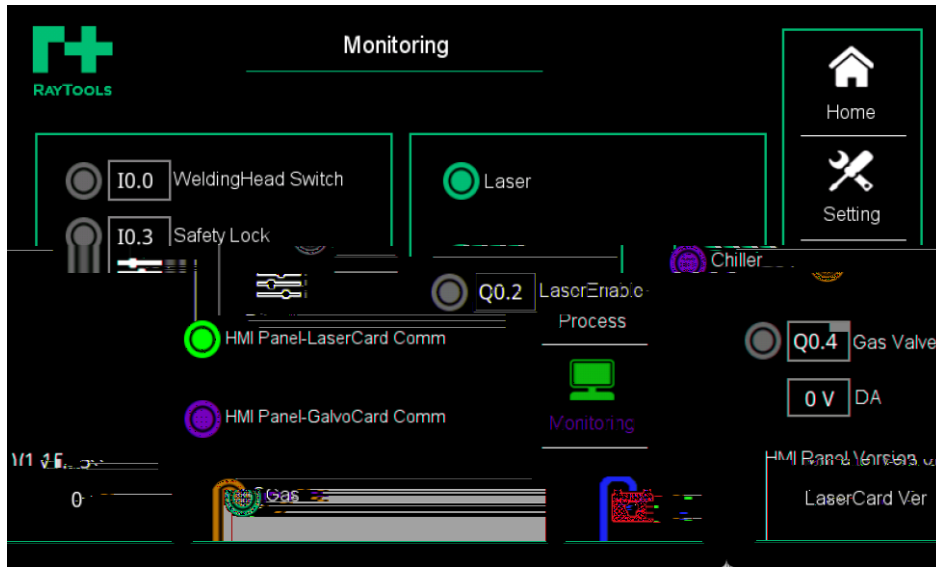

F



F



F

		in	F F
		in	
		in	
		in	
F		in	

F		
		F

F								
			F	F				

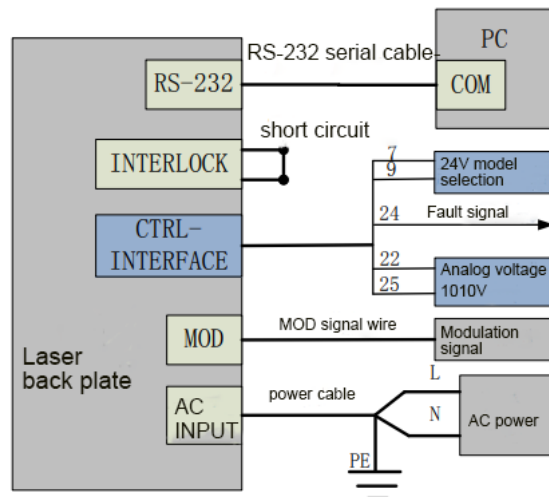

Figure 22 Wiring diagram in AD mode

